



EXCELLENT MEDICAL PRODUCTS CO., LTD.



EXCELLENT Medical Products Co., Ltd. was established in 2003, we are an enterprise professionally for R&D, design, manufacture and sales for medical products and personal care products. We keep innovation and development as our management concept, introduced the advanced production technology and management experience from abroad, develop Europe and USA market continuously. By now, we have three manufacture sites and total area is 45,000 square meters, the medical grade clean room area is 30,000 square meters.

According to different scope of application, we have two main divisions:

-Medical Product Division which covers the production and sales for surgical drapes, surgical gowns and surgical pack.

-Personal Care Product Division which covers the production and sales for incontinence products like disposable underpad, adult diaper and moist wipes.

We EXCELLENT have a young and energetic team for production management, marketing & sales, we have the courage to do innovation and expand market continuously, now we are selling our products to more than 50 countries and areas in Europe, USA, South America, Japan, Middle East countries and Africa, we've been the contracted OEM supplier for some wellknown international brands.

In the situation of increasingly drastic market competition, we know we can survive by excellent quality control and production cost management for the purpose of giving more advantages to our distributors. As an enterprise, we pursue a long term development and excellence, we will always keep the keen perception to the market orientation, adapt ourselves to market development, we wish to get successful business together with our distributors and customers.

If you are interested to our products or have any queries, please feel free to contact with us, we will give you feedback at the earliest time.





U.S. FDA Registraion Number: 3005477161
 CE0123 ISO13485: 2012 by TUV

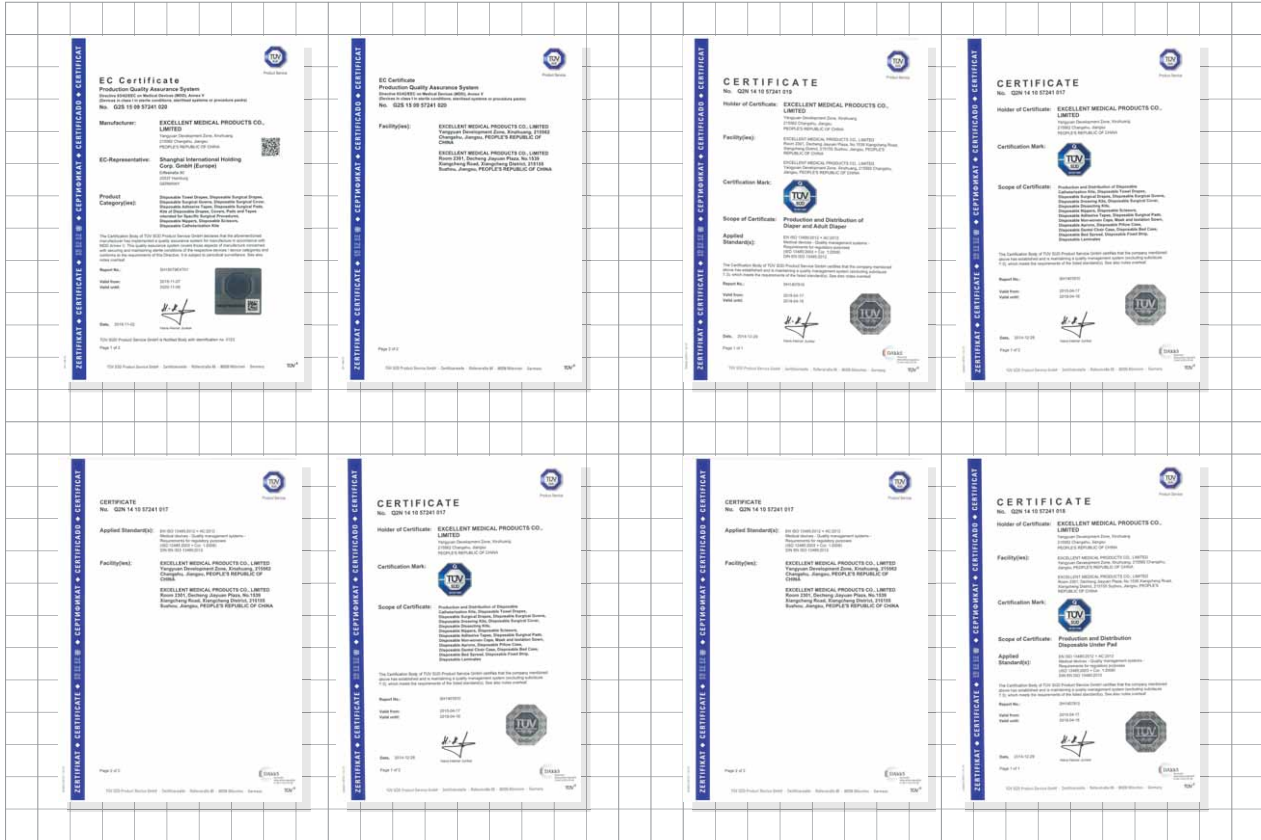

It is important to EXCELLENT
that our products
have least possible impact
on the climate and environment



- Super absorbent polymer (SAP)
- For maximum absorbency
- Wetness indicator



Soft Tabs with both Velcro and Tape, provide double security

Soft and cloth-like non-woven sheet, comfortable for skin care

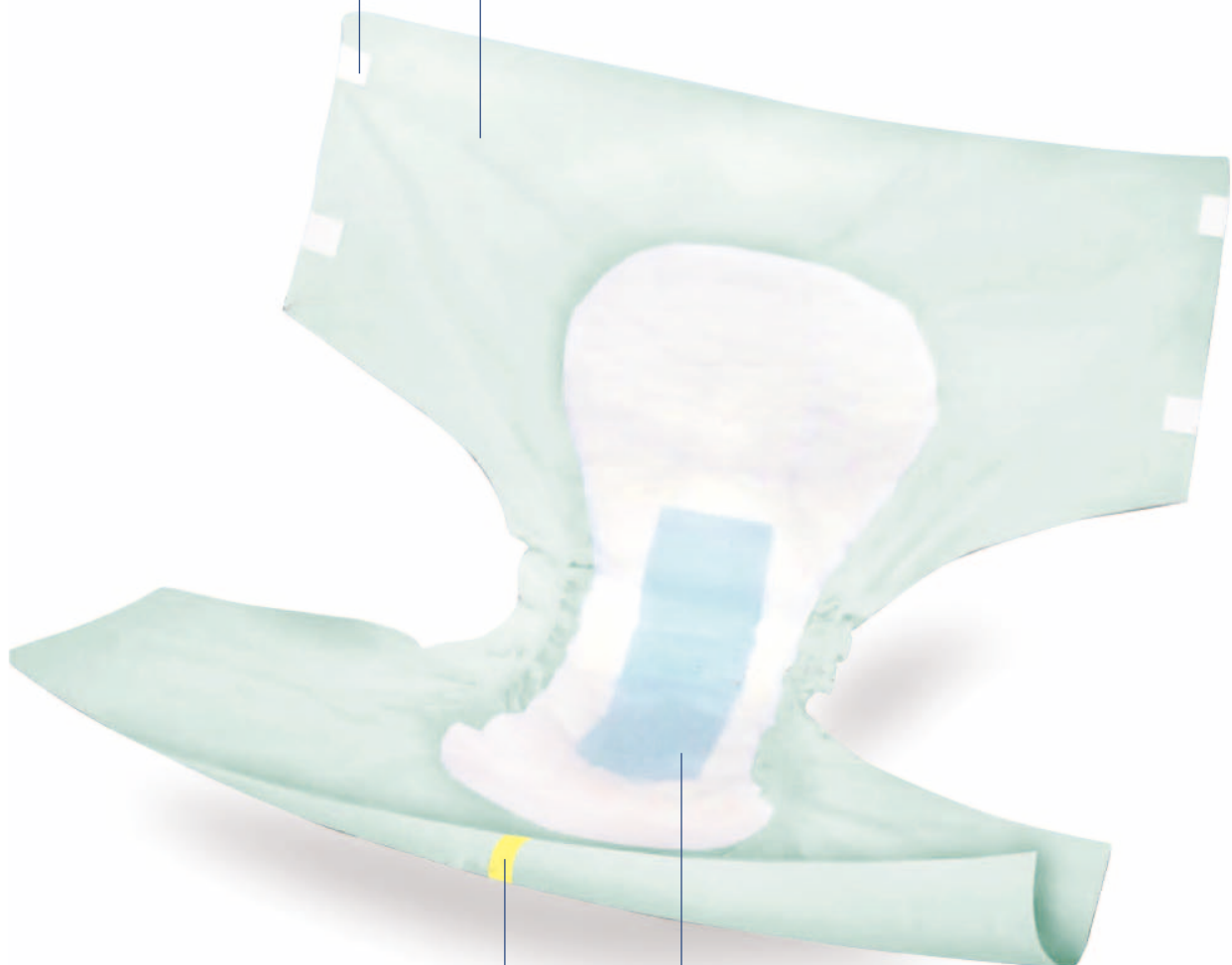

Wetness indicator

Ultra absorbent padding, specially channeled to spread liquid evenly for greater absorption

► Anti-leak guards is available on our Adult Brief.

How to use:



Fully unfold the diaper and extend the flap. Turn the patient sideways and insert diaper with the absorbent mat side under their hind part.



Turn the patient again to the other side of the diaper.



Pull up the frontal part of the diaper and align with the flaps to adjust accordingly. Remove tape backing and fasten the tapes to each side.

Ordering information

Description	Small	Medium	Large	X-Large	XX-Large
Total Weight----g/pcs	94±4	96±4	104±4	106±4	108±4
PE color	White	Purple	Blue	Beige	Green
Waist Size	32"-42" (81cm-107cm)	40"-50" (102cm-127cm)	48"-58" (122cm-147cm)	59"-66" (150cm-168cm)	60"-69" (152cm-175cm)
Tape Tabs Closure System	2	2	2	2	2
Wetness Indicator	Yes Yellow to Blue	Yes Yellow to Blue	Yes Yellow to Blue	Yes Yellow to Blue	Yes Yellow to Blue
Quantity per Case	96pcs	80pcs	72pcs	60pcs	48pcs
Quantity per Bag	16pcs	20pcs	18pcs	15pcs	12pcs
Case Dimension	54.5x46.5x27	51.5x36x27	52x35.5x28	42.5x38x30.5	38x35x30.5
Estimated cs# in a 40" HQ	1100	1400	1320	1360	1700
N.W./ctn (kg)	9	7.6	7.5	6.5	5.2
G.W./ctn (kg)	10	8.6	8.5	7.5	6.2

- Full range sizes from minimum 40cmx60cm to maximum 100cmx300cm
- High absorbency
- Option of Air-permeable for added patient comfort
- Leakage protection
- Absorbent core wicks moisture away from the skin for a better skin care

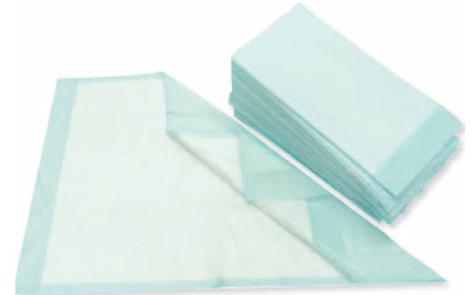

Economy underpad

- Non-woven top layer: soft and comfortable non-woven material
- Absorbent Core: lock the liquid inside the pad
- PE backing: leakage prevention
- Wide variety of sizes and weight to meet different needs
- Customized packaging help distribution in various market channels



Premium underpad

- Fluff and super absorbent polymer (SAP) provides good performance of absorbency
- Dry quickly to the touch of surface
- Choices of sizes and weights to meet every need
- Breathable PE film backing: offers a more air comfort experience
- Customized packing help distribution in various market channels





Polymer underpads for incontinence care

- Disposable Polymer Underpads feature a polymer and fluff core that provides absorbency
- Choices of sizes and weights to meet every need
- Polypropylene backing helps keep underpad in place

Description:

Underpad, economical, 17"x24", 43g

Underpad, economical, 23"x36", 43g

Underpad, standard, 23.5"x23.5", polymer, 50g

Underpad, standard, 23"x36", polymer, 90g

Underpad, standard, 30"x36", polymer, adhesive tape strips, 100g

Underpad, standard, 30"x36", polymer, 100g

Underpad, premium, super absorbency, 23"x36"

Underpad, premium, super absorbency, 30"x36"

Underpad, ultra premium, strong & super absorbency, 30"x36"

Underpad, X-Large, premium, super absorbency, 40"x90"

Underpad, X-Large, premium, strong & super absorbency, 40"x90"

- We can customize more specs as per your market requirement, please contact with our sales for more information.



SURGICAL SETS

As a leading manufacturer of medical devices, our expertise in the operating theatre is reputed for its high level of standards



■ Universal Set

2010009

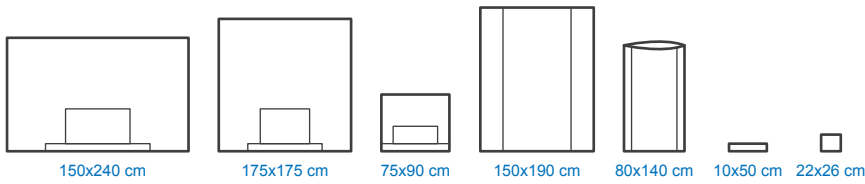

- 1 table cover 150x190 cm
- 1 mayo stand cover 80x140 cm
- 1 adhesive op-sheet 150x240 cm
- 1 adhesive op-sheet 175x175 cm
- 2 adhesive towel 75x90 cm
- 4 cellulose towel 22x26 cm
- 1 op-tape 10x50 cm

■ Laparoscopy Set

2010010

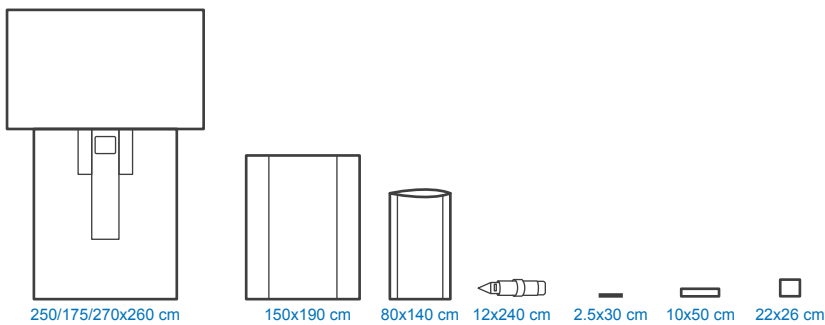

- 1 table cover 150x190 cm
- 1 mayo stand cover 80x140 cm
- 1 laparoscopy drape 250/175/270x260 cm, aperture 25x30 cm
- 1 tube/camera cover perforated tip 12x240 cm
- 1 tube holder velcro 2.5x30 cm
- 1 op-tape 10x50 cm
- 4 cellulose towel 22x26 cm

■ Laparoscopy Set

2010011

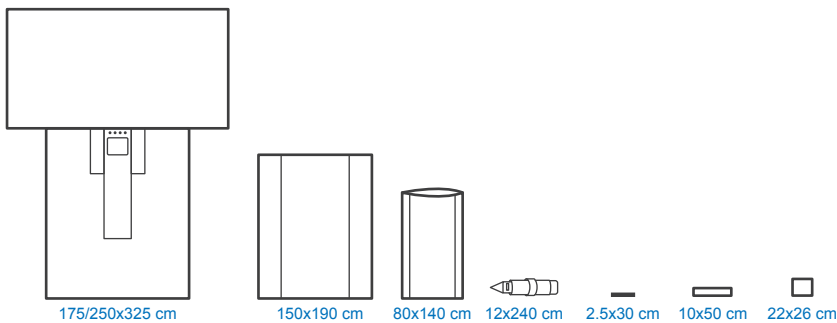

- 1 table cover 150x190 cm
- 1 mayo stand cover 80x140 cm
- 1 laparoscopy drape 175/250x325 cm, aperture 25x30 cm
- 1 tube/camera cover perforated tip 12x240 cm
- 1 tube holder velcro 2.5x30 cm
- 1 op-tape 10x50 cm
- 4 cellulose towel 22x26 cm

■ Tur Set

2010012

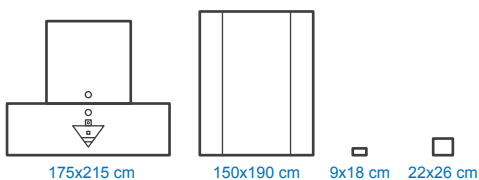

- 1 table cover 150x190 cm
- 1 tur drape 175x215 cm w/pouch, apertures 8 cm and 5 cm, finger cot
- 1 tube holder 9x18 cm
- 1 cellulose towel 22x26 cm

■ Gyn/Laparoscopy Set

2010013

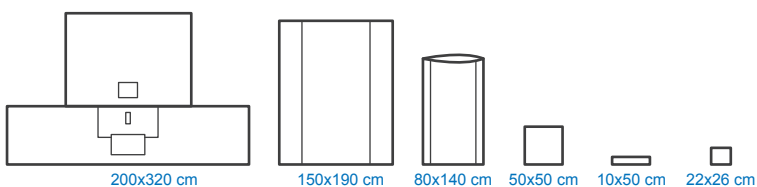

- 1 table cover 150x190 cm
- 1 mayo stand cover 80x140 cm
- 1 laparoscopy drape w/leggings 200x320 cm, apertures 25x20 cm and 6x15 cm
- 2 op-tape 10x50 cm
- 1 adhesive towel 50x50 cm
- 4 cellulose towel 22x26 cm

Cardiovascular Universal Set

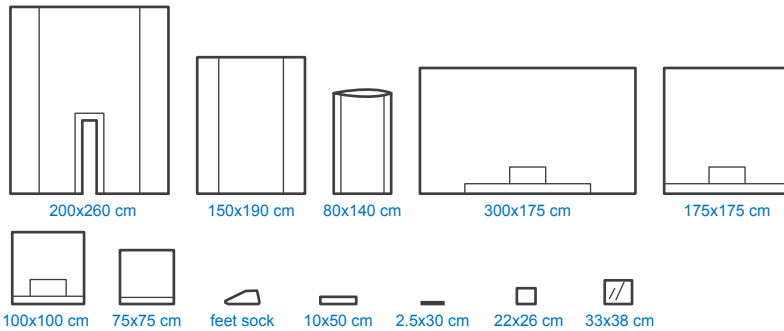

Ophthalmology Drape

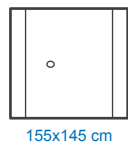

Head/Neck Drape

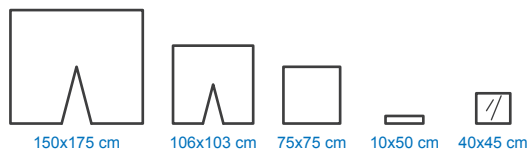

Lithotomy Leggings



Universal Set Eco

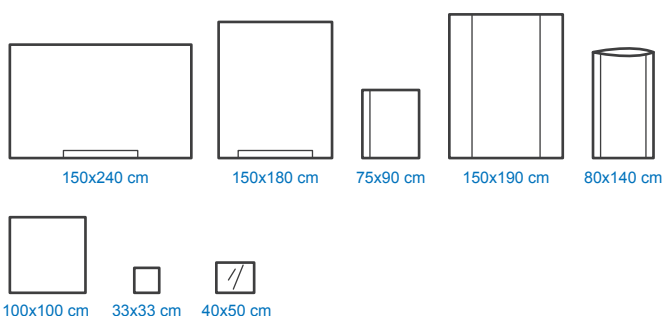

2010014

- 1 table cover 150x190 cm
- 1 mayo stand cover reinforced 80x140 cm
- 1 lower vascular drape 200x260 cm, split 20x102 cm
- 2 tube holder velcro 2.5x30 cm
- 6 cellulose towel 22x26 cm
- 2 defibrillator bag 33x38 cm
- 1 adhesive towel 75x75 cm
- 3 op-tape 10x50 cm
- 2 feet socks
- 2 adhesive towel reinforced 100x100 cm
- 1 adhesive op-sheet standard 175x175 cm
- 1 adhesive op-sheet orthopaedic 300x175 cm

2010016

- 1 155x145 cm, incise area 8x9.5 cm, wrapped

2010018

- 1 150x175 cm, 106x103 cm
- 1 op-tape 10x50 cm
- 1 wrap 75x75 cm
- 1 head bag 40x45 cm

2010022

- 2 lithotomy leggings, 75x120 cm

2010024

- 1 table cover 150x190 cm
- 1 mayo stand cover 80x140 cm
- 1 adhesive drape 150x240 cm
- 1 adhesive drape 150x180 cm
- 2 adhesive drape 75x90 cm
- 2 hand towel 33x33 cm
- 1 wrap 100x100 cm
- 1 head bag 40x50 cm

■ Laparoscopy Set I

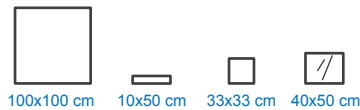
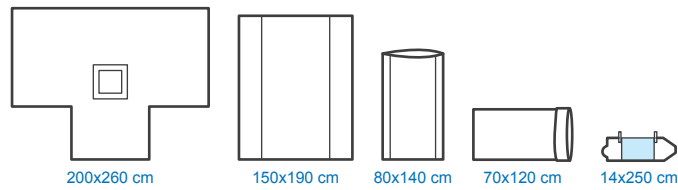

■ Laparoscopy Set II

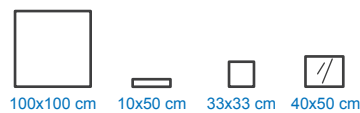
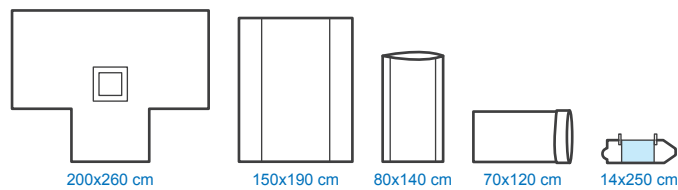

■ Varix Set No.2

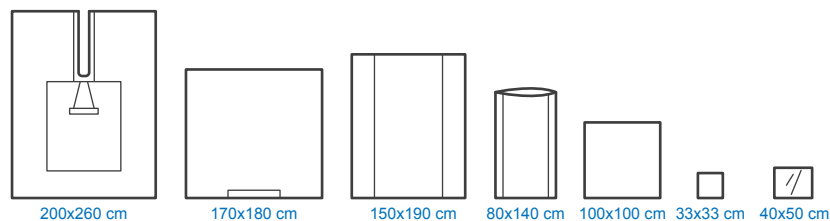

■ Perineal/Abdominal Set II

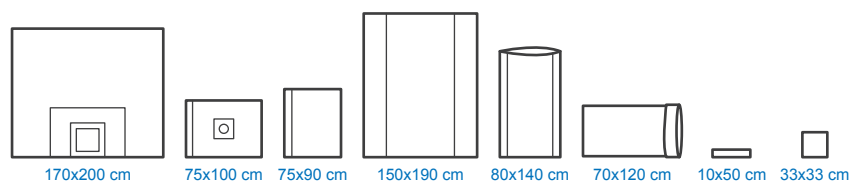

■ Universal Set Large

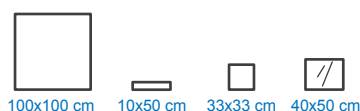
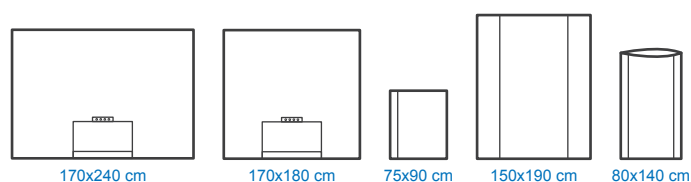

2010025

- 1 table cover 150x190 cm
- 1 mayo stand cover 80x140 cm
- 1 laparoscopy drape with surgical film, 3-ply 200x260 cm, fenestration 30x30 cm
- 2 leggings 70x120 cm
- 1 op-tape 10x50 cm
- 1 camera drape 14x250 cm
- 4 hand towel 33x33 cm
- 1 wrap 100x100 cm
- 1 head bag 40x50 cm

2010026

- 1 table cover 150x190 cm
- 1 mayo stand cover 80x140 cm
- 1 laparoscopy drape ZR. 200x260 cm fenestration 30x30 cm, adhesive
- 2 leggings 70x120 cm
- 1 op-tape 10x50 cm
- 1 camera drape 14x250 cm
- 4 hand towel 33x33 cm
- 1 wrap 100x100 cm
- 1 head bag 40x50 cm

2010027

- 1 table cover 150x190 cm
- 1 mayo stand cover 80x140 cm
- 1 u-split drape, central reinforced 200x260 cm
- 1 adhesive drape 2-ply 170x180 cm
- 4 hand towel 33x33 cm
- 1 wrap 100x100 cm
- 1 head bag 40x50 cm

2010028

- 1 table cover 150x190 cm
- 1 mayo stand cover 80x140 cm
- 1 abdominal drape 170x200 cm, reinforced adhesive hole 30x30cm
- 1 perineal drape 75x100 cm, reinforced with hole Φ 12cm adhesive
- 1 adhesive drape 75x90 cm
- 2 leggings 70x120 cm
- 2 op-tape 10x50 cm
- 2 hand towel 33x33 cm

2010029

- 1 table cover 150x190 cm
- 1 mayo stand cover 80x140 cm
- 1 adhesive drape 170x180 cm, with cable holer
- 1 adhesive drape 170x240 cm, with cable holer
- 2 adhesive drape 75x90 cm
- 1 op-tape 10x50 cm
- 4 hand towel 33x33 cm
- 1 wrap 100x100 cm
- 1 head bag 40x50 cm

■ Hip Set I

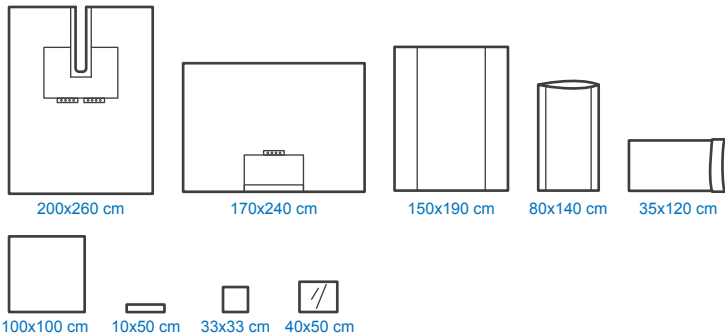

2010030

- 1 table cover 150x190 cm
- 1 mayo stand cover 80x140 cm
- 1 u-split drape with cable holers 200x260 cm, fenestration 8.5x85 cm
- 1 adhesive drape with cable holder 170x240 cm
- 1 leggings 35x120 cm
- 2 op-tape 10x50 cm
- 4 hand towel 33x33 cm
- 1 wrap 100x100 cm
- 1 head bag 40x50 cm

■ Hip Set II

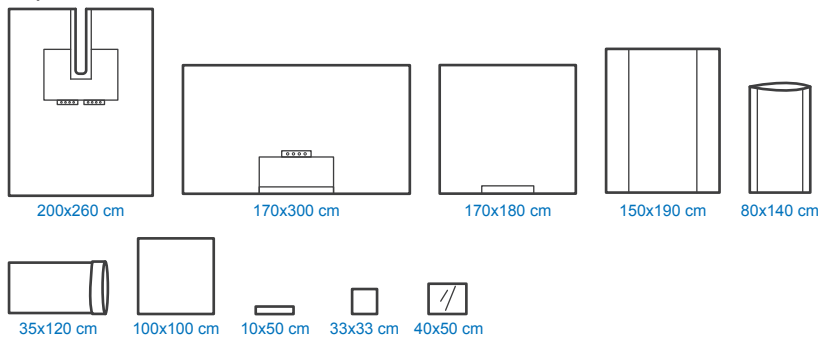

2010031

- 1 table cover 150x190 cm
- 1 mayo stand cover 80x140 cm
- 1 u-split drape with cable holers 200x260 cm, fenestration 8.5x85 cm
- 1 adhesive drape with cable holder 170x300 cm
- 1 adhesive drape 170x180 cm
- 1 leggings 35x120 cm
- 2 op-tape 10x50 cm
- 4 hand towel 33x33 cm
- 1 wrap 100x100 cm
- 1 head bag 40x50 cm

■ Rectum Set I

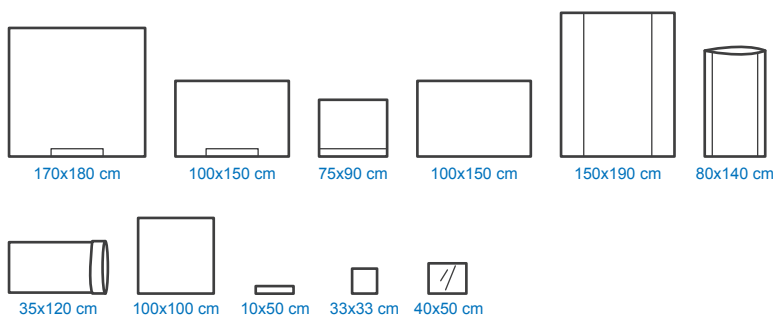

2010033

- 1 table cover 150x190 cm
- 1 mayo stand cover 80x140 cm
- 1 adhesive drape 170x180 cm
- 2 adhesive drape 100x150 cm
- 1 adhesive draoe 75x90 cm
- 1 drape 100x150 cm
- 2 leggings 70x120 cm
- 1 op-tape 10x50 cm
- 4 hand towel 33x33 cm
- 1 wrap 100x100 cm
- 1 head bag 40x50 cm

■ Arthroscopy Set I

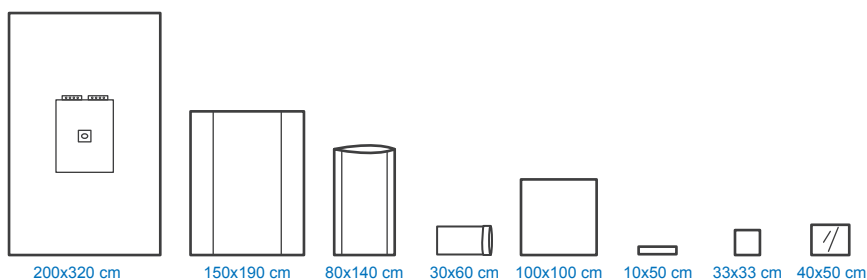

2010034

- 1 table cover 150x190 cm
- 1 mayo stand cover 80x140 cm
- 1 arthroscopy drape with cable holers, 200x320 cm, elastic fenestration 6x8 cm
- 1 leggings 30x60 cm
- 1 op-tape 10x50 cm
- 4 hand towel 33x33 cm
- 1 wrap 100x100 cm
- 1 head bag 40x50 cm

■ Arthroscopy Set II

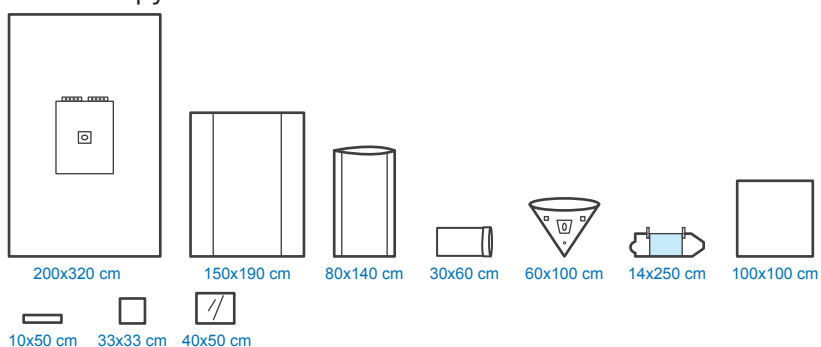

2010035

- 1 table cover 150x190 cm
- 1 mayo stand cover 80x140 cm
- 1 arthroscopy drape with cable holers, 200x320 cm, elastic fenestration 6x8 cm
- 1 arthroscopy fluid collection bag 60x100 cm
- 1 camera drape 14x250 cm
- 1 leggings 30x60 cm
- 2 op-tape 10x50 cm
- 2 hand towel 33x33 cm
- 1 wrap 100x100 cm
- 1 head bag 40x50 cm

Shoulder Set

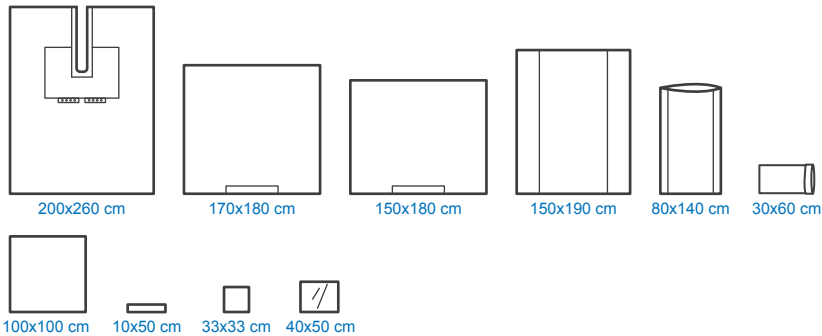

2010038

- 1 table cover 150x190 cm
- 1 mayo stand cover 80x140 cm
- 1 u-split drape with cable holders 200x260 cm fenestration 8.5x85 cm
- 1 adhesive drape 150x180 cm
- 1 adhesive drape 170x180 cm
- 1 leggings 30x60 cm
- 1 op-tape 10x50 cm
- 4 hand towel 33x33 cm
- 1 wrap 100x100 cm
- 1 head bag 40x50 cm

Hallux Set

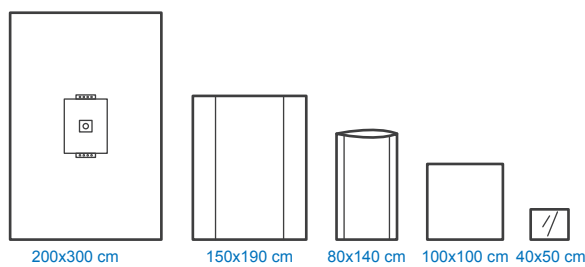

2010039

- 1 table cover 150x190 cm
- 1 mayo stand cover 80x140 cm
- 1 extremity drape with cable holders, 200x300 cm, elastic fenestration Φ 3.5 cm
- 1 wrap 100x100 cm
- 1 head bag 40x50 cm

Cystoscopy Set Small

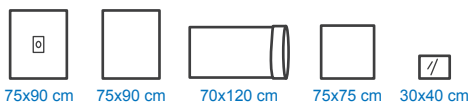

2010040

- 1 table cover 75x90 cm
- 2 leggings 70x120 cm
- 1 adhesive drape with hole 2-ply 75x90 cm fenestration 6x8 cm adhesive
- 1 wrap 75x75 cm
- 1 head bag 30x40 cm

Uro/Gyn Set Eco

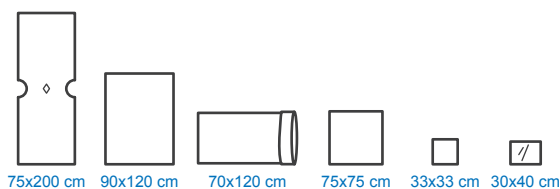

2010041

- 1 table cover 90x120 cm
- 2 leggings 70x120 cm
- 1 URO/GYN drape 75x200 cm, fenestration 8x12 cm
- 4 hand towel 33x33 cm
- 1 wrap 75x75 cm
- 1 head bag 30x40 cm

Uro/Gyn Set II

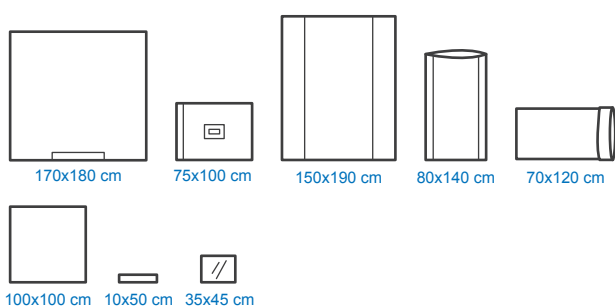

2010042

- 1 table cover 150x190 cm
- 1 mayo stand cover 80x140 cm
- 2 leggings 70x120 cm
- 1 adhesive drape 170x180 cm
- 1 genital drape 75x100 cm, fenestration 6x14 cm, adhesive
- 1 op-tape 10x50 cm
- 1 wrap 100x100 cm
- 1 head bag 35x45 cm

Tur Set

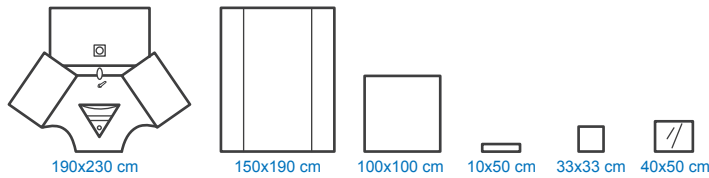

2010043

- 1 table cover 150x190 cm
- 1 TUR drape with abdominal and perineal fenestration, finger coat and irrigation pouch 190x230 cm
- 1 op-tape 10x50 cm
- 4 hand towel 33x33 cm
- 1 wrap 100x100 cm
- 1 head bag 40x50 cm

C-section Set

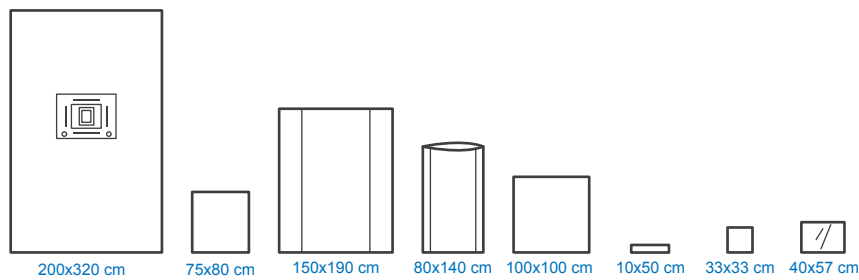

2010044

- 1 table cover 150x190 cm
- 1 mayo stand cover 80x140 cm
- 1 drape ZR 200x320 cm with incise film and fluid collection bag fenestration 25x30 cm
- 1 absorbent baby towel 75x80 cm
- 1 adhesive tape 10x50 cm
- 4 hand towel 33x33 cm
- 1 wrap 100x100 cm
- 1 head bag 40x57 cm

Hysterectomy Set I

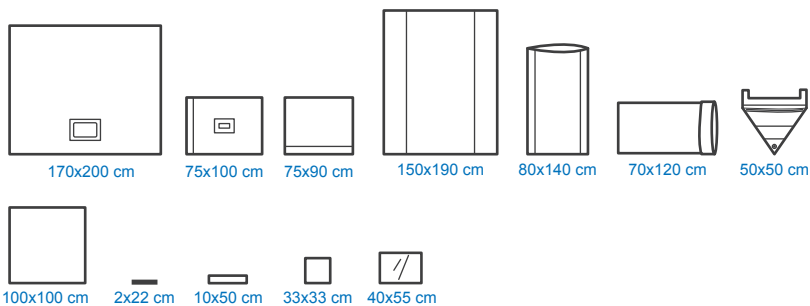

2010045

- 1 table cover 150x190 cm
- 1 mayo stand cover 80x140 cm
- 1 abdominal drape 170x200 cm, 3-ply fenestration 30x30 cm with incise film
- 1 genital drape 75x100 cm fen. 6x14 cm, adhesive
- 2 leggings 70x120 cm
- 1 adhesive drape 2-ply 75x90 cm
- 1 irrigation pouch with filter tubing port 50x50 cm
- 1 op-tape 10x50 cm
- 1 velcro cable holder 2x22 cm
- 4 hand towel 33x33 cm
- 1 wrap 100x100 cm
- 1 head bag 40x55 cm

Uro/Gyn Set Special

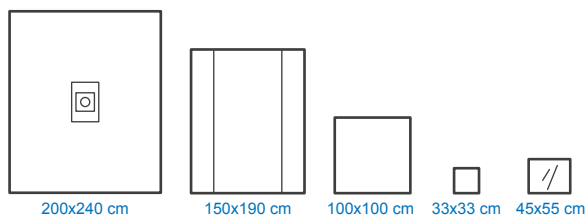

2010046

- 1 table cover 150x190 cm
- 1 fenestrated drape 200x240 cm, fenestration Φ 12 cm, adhesive
- 2 hand towel 33x33 cm
- 1 wrap 100x100 cm
- 1 head bag 45x55 cm

Delivery Set I

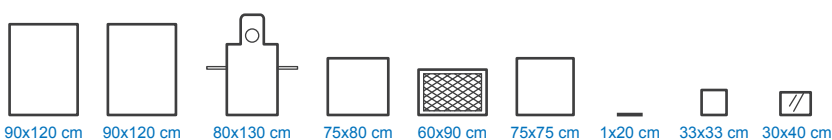

2010047

- 1 table cover 90x120 cm
- 1 drape T2, 90x120 cm
- 1 apron, 80x130 cm
- 1 absorbent underpad 60x90 cm
- 1 baby towel 75x80 cm
- 6 absorbent towel 33x33 cm
- 1 umbilical string 1x20 cm
- 1 wrap 75x75 cm
- 1 head bag 30x40 cm

Delivery Set II

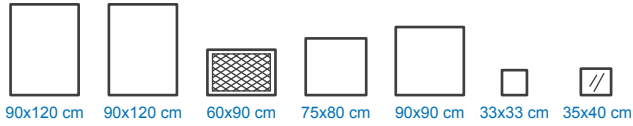

2010048

- 1 table cover 90x120 cm
- 1 drape 90x120 cm
- 2 absorbent underpad 60x90 cm
- 1 baby towel 75x80 cm
- 6 absorbent towel 33x33 cm
- 1 wrap 90x90 cm
- 1 head bag 35x40 cm

Delivery Set III

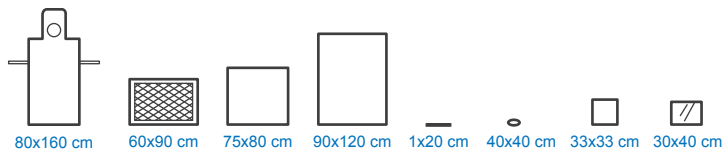

2010049

- 1 table cover 90x120 cm
- 1 apron, 80x160 cm
- 1 absorbent underpad 60x90 cm
- 3 baby towel 75x80 cm
- 2 absorbent towel 33x33 cm
- 10 gauze balls 40x40 cm
- 1 umbilical string 1x20 cm
- 1 head bag 30x40 cm

Delivery Standard Set

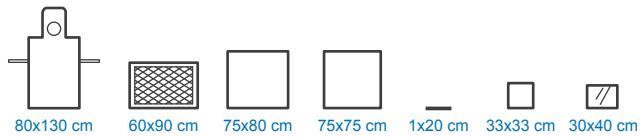

2010050

- 1 apron 80x130 cm
- 1 absorbent under towel 60x90 cm
- 3 absorbent towel 75x80 cm
- 2 absorbent towel 33x33 cm
- 1 umbilical string 1x20 cm
- 1 wrap 75x75 cm
- 1 head bag 30x40 cm

Cardiovascular Set

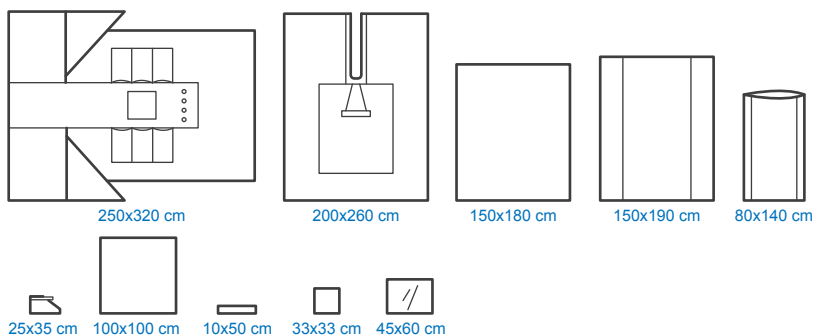

2010051

- 1 table cover 150x190 cm
- 1 mayo stand cover 80x140 cm
- 1 thorax drape 250x320 cm with surgical film 35x40 cm and 6 pockets
- 1 u-split drape 200x260 cm, adhesive
- 1 drape 150x180 cm
- 2 leggings 25x35 cm
- 2 op-tape 10x50 cm
- 4 hand towel 33x33 cm
- 1 wrap 100x100 cm
- 1 head bag 45x60 cm

Angiography Set II

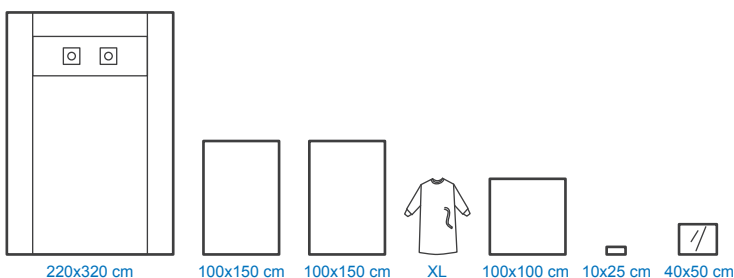

2010052

- 1 table cover 100x150 cm
- 1 drape 100x150 cm
- 1 two-sided fenestration drape 220x320 cm double adhesive fenestrations 10 cm
- 1 surgical gown STANDARD size XL
- 1 op-tape 10x25 cm
- 1 wrap 100x100 cm
- 1 head bag 40x50 cm

■ Angiography Set Special

42000430

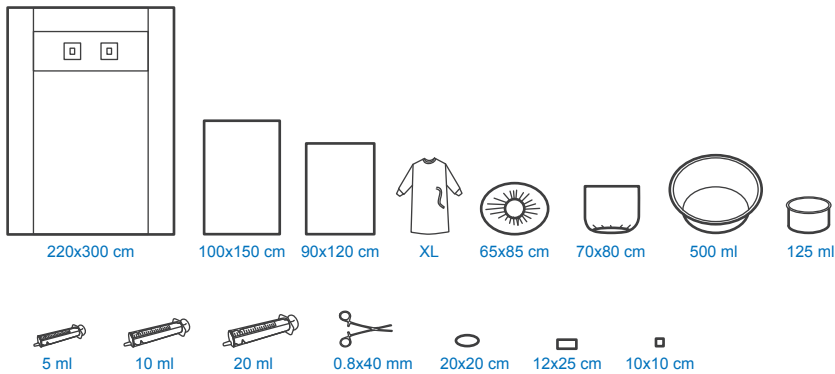

- 1 serweta na stół 100x150 cm
- 1 serweta 2-ply 90x120 cm
- 1 two-sided angiography drape 220x300 cm double adhesive fenestrations 6x8 cm
- 1 surgical gown standard size XL
- 4 op-tape 12x25 cm
- 1 fluoroscopy cover 65x85 cm
- 1 X-ray shield 70x80 cm flatt
- 2 plastic bowl 500 ml
- 1 plastic cup 125 ml
- 1 syringe 5 ml
- 1 syringe 20 ml
- 2 syringe 10 ml luer lock
- 1 needle 0.8x40 mm
- 1 puncture needle cook18G
- 1 swab clamp 4X gauze balls 20x20 cm + 20X gauze swabs 10x10+2X hand towels

■ Basic Ophthalmic Set

2010055

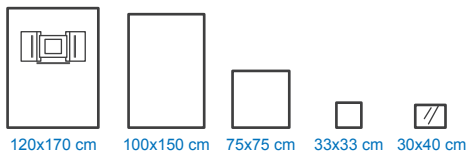

- 1 table cover 100x150 cm
- 1 ophthalmic drape with incise film and two f/c pouches, 120x170 cm
- 2 hand towel 33x33 cm
- 1 wrap 75x75 cm
- 1 head bag 30x40 cm

■ Universal Ophthalmic Set

2010056

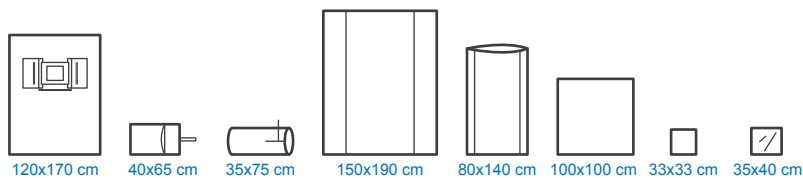

- 1 table cover 150x190 cm
- 1 mayo stand cover 80x140 cm
- 1 ophthalmic drape ZR with incise film and two f/c pouches, 120x170 cm
- 1 phaco tray cover 40x65 cm
- 2 armboard cover 35x75 cm
- 2 hand towel 33x33 cm
- 1 wrap 100x100 cm
- 1 head bag 35x40 cm

■ U-split Ent Set

2010057

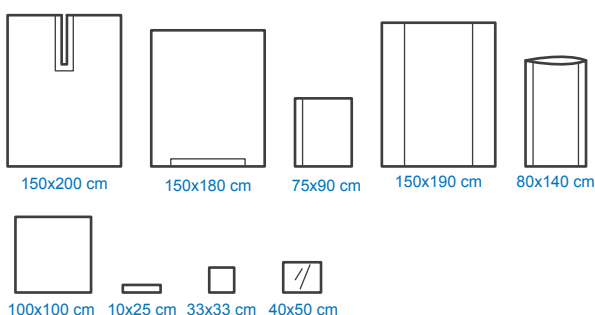

- 1 table cover 150x190 cm
- 1 mayo stand cover 80x140 cm
- 1 u-split drape 150x200 cm, fenestration 6x65 cm, adhesive
- 1 adhesive drape 150x180 cm
- 1 adhesive drape 75x90 cm
- 1 op-tape 10x50 cm
- 4 hand towel 33x33 cm
- 1 wrap 100x100 cm
- 1 head bag 40x50 cm

Varix Set

2010058

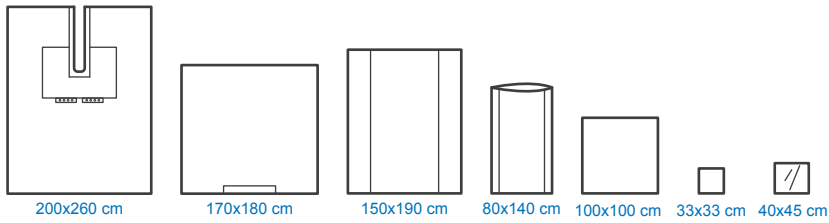

- 1 table cover 150x190 cm
- 1 mayo stand cover 80x140 cm
- 1 u-split drape 200x260 cm, fenestration 8.5x85 cm, adhesive
- 1 adhesive drape 170x180 cm
- 4 hand towel 33x33 cm
- 1 wrap 100x100 cm
- 1 head bag 40x45 cm

Basic Ent Set

2010059

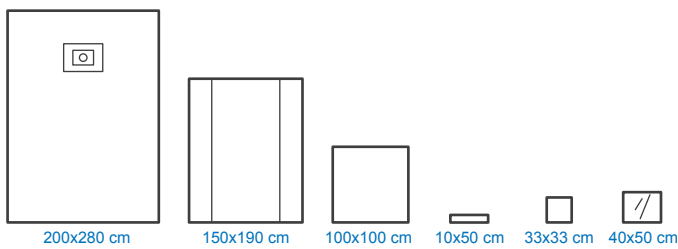

- 1 table cover 150x190 cm
- 1 fenestrated drape 200x280 cm, fenestration Φ 10 cm
- 1 op-tape 10x50 cm
- 2 hand towel 33x33 cm
- 1 wrap 100x100 cm
- 1 head bag 40x50 cm

Abdominal Set

2010064

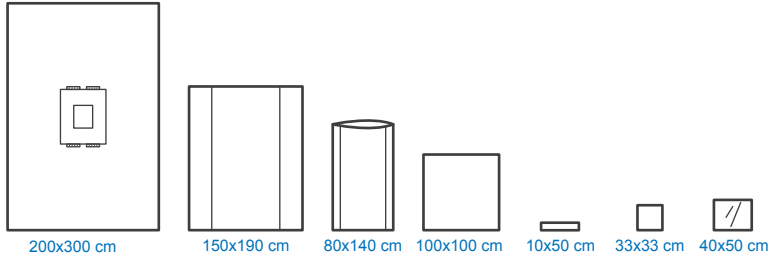

- 1 table cover 150x190 cm
- 1 mayo stand cover 80x140 cm
- 1 abdominal drape 200x300 cm, 3-ply, with surgical film, hole 25x30 cm
- 1 op-tape 10x50 cm
- 4 hand towel 33x33 cm
- 1 wrap 100x100 cm
- 1 head bag 40x50 cm



SURGICAL GOWN

Surgical gowns play an important part in eliminating route of infection through the provision of safe, disposable products.



■ SMS Surgical Gown

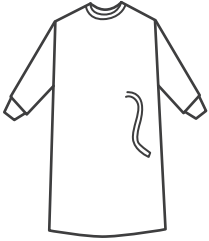

standard

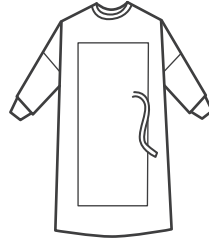

reinforced

Standard gown / Ultrasonic welding

Material: SMS (35/43/50gsm)

Size: S / M / L / XL / XXL

Reinforced gown / Ultrasonic welding

Material: SMS (35/43/50gsm)

Size: S / M / L / XL / XXL

■ Spunlace Surgical Gown

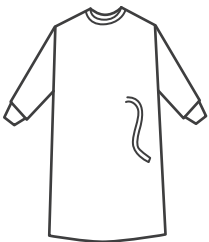

standard

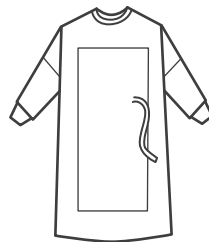

reinforced

Standard gown / Sewing

Material: spunlace (68gsm)

Size: S / M / L / XL / XXL

Reinforced gown / Sewing

Material: spunlace (68gsm)

Size: S / M / L / XL / XXL

■ Urological Gown

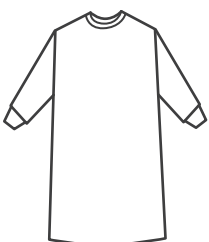

front



back

Urological gown / Ultrasonic welding

Material: PE +SMS lamination

Size: S / M / L / XL / XXL

- Surgical drapes

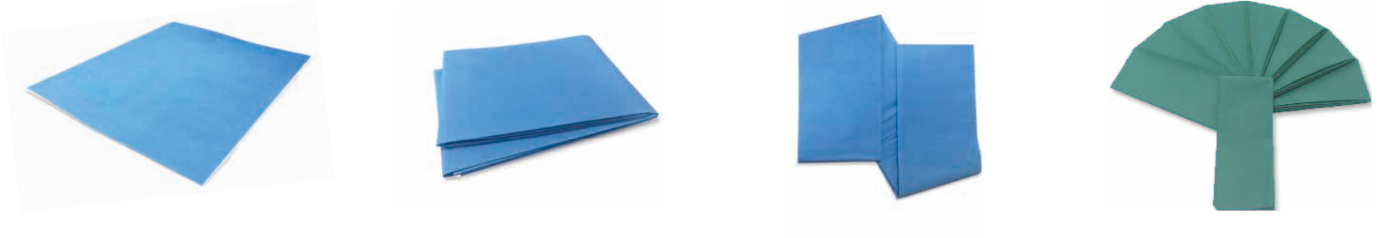

- Surgical drapes with adhesive/aperture

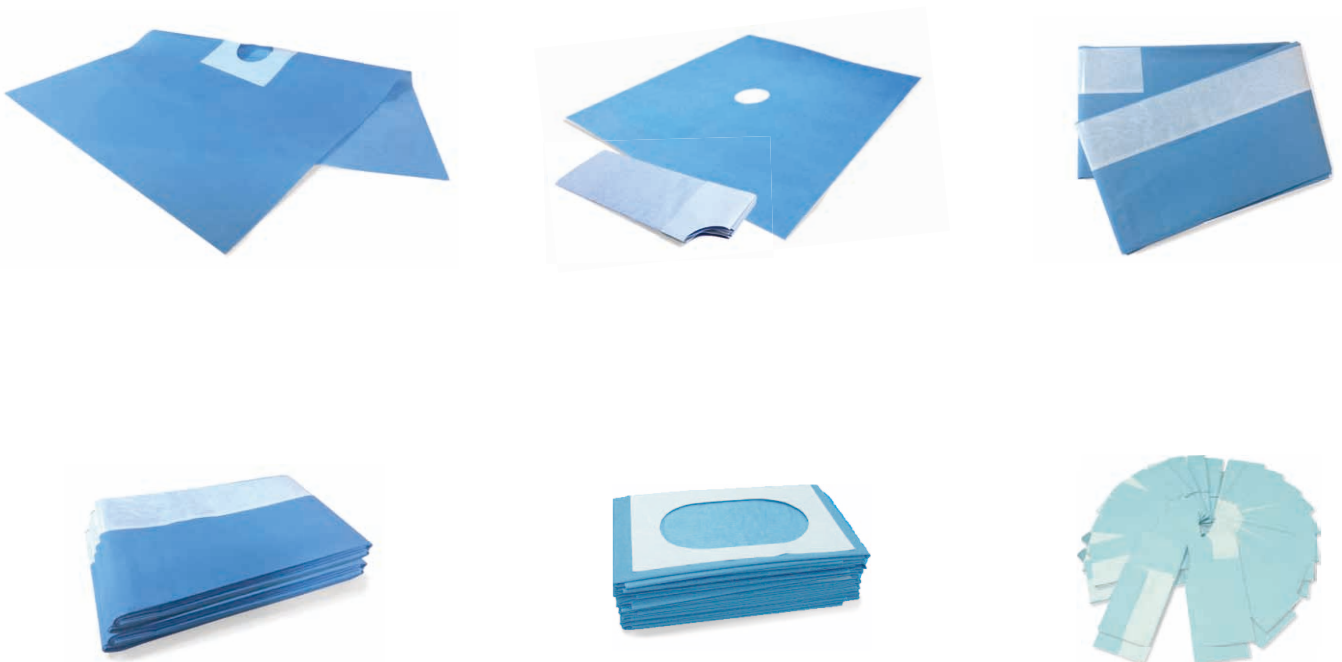

ADD: Room 2301, Decheng Jiayuan Plaza,
No.1539 Xiangcheng Road, Xiangcheng District,
Suzhou, Jiangsu, 215131 China
TEL: 0086-512-69398826
FAX: 0086-512-69398803
E-mail: excellent33@hgjd.com